

1971

Determining the temperature of hot solid bodies by means of photographic pyrometry, using the two-filter comparison method

Edward White

Follow this and additional works at: <http://scholarworks.rit.edu/theses>

Recommended Citation

White, Edward, "Determining the temperature of hot solid bodies by means of photographic pyrometry, using the two-filter comparison method" (1971). Thesis. Rochester Institute of Technology. Accessed from

This Senior Project is brought to you for free and open access by the Thesis/Dissertation Collections at RIT Scholar Works. It has been accepted for inclusion in Theses by an authorized administrator of RIT Scholar Works. For more information, please contact ritscholarworks@rit.edu.

DETERMINING THE TEMPERATURE OF HOT SOLID BODIES
BY MEANS OF PHOTOGRAPHIC PYROMETRY, USING THE
TWO-FILTER-COMPARISON METHOD

by

Edward J. White

A thesis submitted in partial fulfillment of
requirements for the degree of Bachelor of
Science in the Department of Photographic
Science in the School of Photographic Arts and
Sciences of the Rochester Institute of Technology

May 21, 1971

Thesis advisor: Dr. Gerhard W. Schumann

ACKNOWLEDGMENTS

I wish to give special thanks to the Central Intelligence Agency for their grant to the Rochester Institute of Technology School of Photographic Science. It was through my fortune to share in this grant that I was financially able to complete this research.

Also, I wish to thank Dr. Gerhard W. Schumann, my research professor and project advisor, whose much appreciated guidance and counselling led me safely over the rough spots of the past year.

For their loans of materials, apparatus, and technical assistance, I extend thanks to Mr. Richard Norman, photo science machine shop; Mr. Robert Sponholz, bio-medical photography; Mr. John F. Carson, Staff Chairman, Photo Science; Mr. Charles Cherenza, Electrical Engineering; Dr. Norman Goldblatt, Physics; and Mr. Richard Johnson, student, Photo Science.

TABLE OF CONTENTS

	<u>PAGE</u>
Abstract	1
Introduction	3
Theory	5
Design and Preparation of Apparatus	9
Film	12
Lamp	13
Photometer Edge	13
Camera System	14
Complete System	15
Experimental Work	16
Determination of Percent of Error	24
Conclusions	25
Recommendations	25
Bibliography	26

LIST OF TABLES

PAGE

1. Calibration Curve Data	18
2. Percentage of Error	24

LIST OF FIGURES

	<u>PAGE</u>
1. A Single-Filter Calibration Curve	4
2. Theoretical Imaging System	6
3. Determination of Ratio $R = \frac{E_1}{E_2}$	7
4. Theoretical Calibration Curve	8
5. Spectral Emittance Curve and Spectral Sensitivity Curve ...	10
6. Total Response Curve	11
7. Electrical Apparatus	13
8. Photometer Edge	14
9. Camera System	14
10. Complete System (Top View)	15
11. Color Temperature vs Amps	17
12. Characteristic Curve for 2481 Infrared Film	19
13. Density vs Amps	20
14. Log E vs Amps	21
15. E vs Amps	22
16. Calibration Curve (R vs Amps)	23

ABSTRACT

A means of determining the temperature of a hot solid body by photographic means has been developed. For the purposes of this experiment, a General Electric tungsten ribbon filament lamp, with an operating range of 12 to 18 amperes was used as the object. From published curves, it was found that the color temperature of the filament varied from 2220°K to 2990°K over the above amperage range. It is therefore possible to vary the color temperature with a powerstat and to monitor it with an ammeter.

Using two front surfaced mirrors, the lamp illuminated both sides of a photometric edge so that they both received equal initial illumination. Two different spectral transmission filters were placed in the system, one in the path of each beam, so that each side of the photometer edge was now illuminated by different wavelengths of radiation. One filter was a Kodak 89B wratten filter, which transmits radiation above 730 nm up to 900 nm, but blocks radiation below 730 nm. The second filter was a Kodak #301 infrared cutoff filter which transmits in the visible range from 400 to 730 nm but blocks infrared radiation above 730 nm. At a given lamp temperature, the edge was imaged onto Kodak 2481 High Speed Infrared film, which was then processed

according to a standardized method. The densities of each side of the image, each exposed by different wavelengths as explained above, are measured, and the corresponding log exposures and exposures are determined from a previously prepared characteristic curve of the film. From this data, a ratio $R = \frac{E_{301}}{E_{89B}}$ was determined. Since this value varied with changing illumination (hence, color temperature), the above procedure was repeated for several color temperatures within the above-mentioned range. The result was a calibration curve of R as a function of color temperature.

It was now possible to determine the value of an unknown temperature of the lamp. The above procedure was repeated with the lamp at an unknown setting. By extrapolating the R value for the unknown temperature on the calibration curve, it was possible to determine the color temperature of the lamp. The average percentage of error in this process was found to be below 1.0%.

INTRODUCTION

The United States Air Force and NASA have been studying re-entry properties of nose-cones and heat shields of missiles and other space vehicles by simulating re-entry conditions on high-speed monorail rocket test sleds. One property of major interest has been an accurate measurement of the temperatures which these nose-cones reach under these test conditions. Sophisticated optical pyrometers and other similar apparatus exist, which can give extremely accurate measurements, provided the the subject remains stationary long enough to be visually examined. This instrumentation is not capable of measuring objects traveling at the high speeds of the rocket sled.

In industry, a photographic method exists in which the infra-red radiation from a hot object is imaged onto an infra-red sensitive emulsion through filters transmitting only those wavelengths equal to or greater than that of infra-red radiation. Since the radiance of the source is a function of its temperature, it is possible to produce calibration curves relating density of the image to the temperature of the source (Fig. 1).

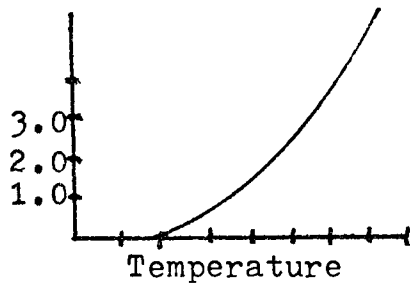

Fig.1. A single-filter calibration curve

This method, however, has a severe disadvantage in our case, due to the fact that the exposure times are too long, as long as several seconds, and it is not very accurate.

Due to the high speed of our test object on the sled, a method is needed in which the necessary information can be obtained with an instantaneous exposure.

The temperature can be determined by photometry, applying the radiometric concepts of Planck's Law and the radiometric curve. Our method utilizes the entire visible spectrum plus low-wavelength infra-red, giving results with acceptable accuracy.

The objectives of this research, therefore, were to design a two-filter system to determine, photographically, the temperature of a hot body (in this case a tungsten filament lamp), and to test it for accuracy.

THEORY

The spectral radiant emittance of a perfect black body is a function of its temperature and the wavelength of the emitted radiation. According to Planck's Law:

$$W_{\lambda} = \frac{C_1}{\lambda^5 (e^{C_2/\lambda T} - 1)} \quad (1)$$

where: W_{λ} = Radiation emitted into a hemisphere by the blackbody in power-per-unit-per-wavelength interval (watt cm⁻²micron⁻¹).

λ = Wavelength (Microns)

e = 2.718

T = Black body temperature in degrees Kelvin

C_1 = 3.7405×10^4

C_2 = 1.43879×10^4

From Wien's displacement law, we can determine the wavelength of maximum W as:

$$\lambda_{\max} = 2897.8 T^{-1} \text{ microns} \quad (2)$$

and W_{λ} at λ_{\max} as:

$$W_{\lambda \max} = 1.28 \times 10^{-15} T^5 \text{ watt cm}^{-2} \text{ micron}^{-1} \quad (3)$$

When dealing with gray-bodies (less than perfect absorption of radiation) such as tungsten, it is necessary

to introduce the emissivity factor (ϵ) into the above black body equations:

$$W_{\lambda} = \frac{\epsilon C_1}{\lambda^5 (e^{C_2/\lambda T} - 1)} \quad (4)$$

$$\lambda_{\max} = 2897.8 \epsilon T^{-1} \text{ micron} \quad (5)$$

$$W_{\lambda, \max} = 1.28 \times 10^{-15} \epsilon T^5 \text{ watt cm}^{-2} \text{ micron}^{-1} \quad (6)$$

The value of the emissivity (ϵ) varies with the temperature. The correct value can be found in standard tables. It will be noted that, as the temperature increases, the wavelength of peak radiation decreases.

Consider the following system:

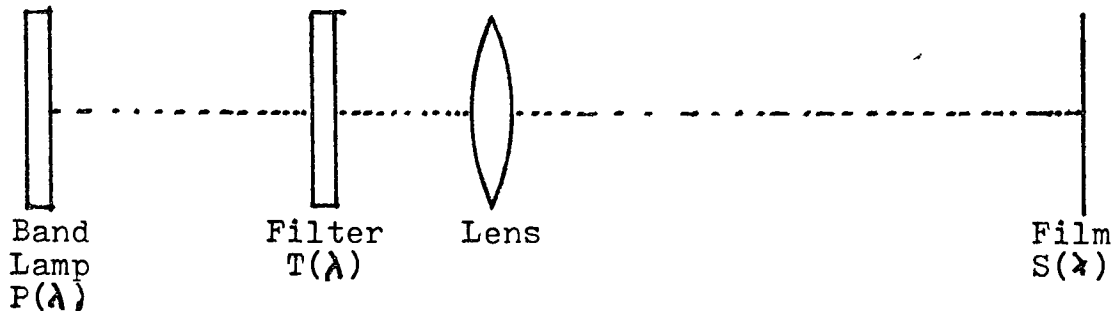

Fig. 2. Theoretical Imaging system

This system consists of a band lamp LIGHT SOURCE with an output $P(\lambda)$, dependent on wavelength and temperature, a FILTER with transmittance $T(\lambda)$, and FILM with spectral sensitivity $S(\lambda)$, with a lens to image the lamp onto the film.

The total response (H) of the system is represented as;

$$H = \int P(\lambda) T(\lambda) S(\lambda) d\lambda \quad (7)$$

If we make two exposures of the band lamp at the same temperature and with the same film, but through filters of different spectral transmission, we will have two response functions:

$$H_1 = P(\lambda) T_1(\lambda) S(\lambda) d\lambda$$

$$H_2 = P(\lambda) T_2(\lambda) S(\lambda) d\lambda$$

We can now define a ratio $R = \frac{H_1}{H_2}$.

If we let response $H =$ Exposure E ,

$$R = \frac{H_1}{H_2} = \frac{E_1}{E_2} \quad (8)$$

It is now possible to record the average density (D) of each image and to plot the results on a standard $D \log E$ curve for the film and process being used.

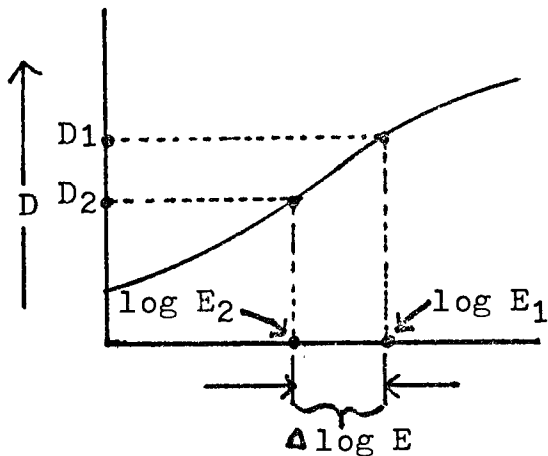

Fig. 3. Determination of
Ratio $R = \frac{E_1}{E_2}$

$$\Delta \log E = \log E_1 - \log E_2 = \log \frac{E_1}{E_2} = \log R \quad (9)$$

$$R = \frac{E_1}{E_2} \quad (10)$$

Repeating the above procedure for the lamp at different temperatures, different values of Ratio R will be obtained. It is now possible to plot R as a function of temperature T.

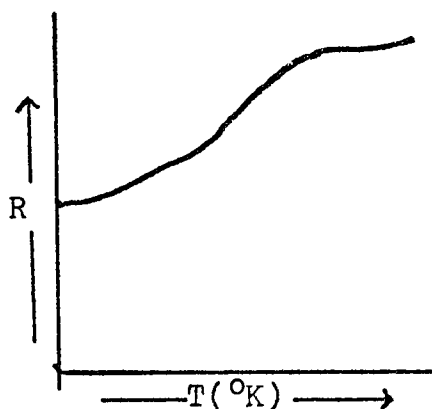

Fig. 4. Theoretical Calibration Curve.

By repeating the procedure with the lamp at an unknown temperature, we can determine a ratio R for that unknown, and find its corresponding temperature on the curve.

DESIGN AND PREPARATION OF APPARATUS

Determination of Filters

It is very important to select the proper filters to place in the photometer edge apparatus.

Consider Equation (7):

$$\text{TOTAL RESPONSE } H = \int P(\lambda) S(\lambda) T(\lambda) d$$

$P(\lambda)$ of a specific wavelength can be calculated according to Plank's Law (Equation (1)) or from published tables of tungsten spectral emittance at specific temperatures and wavelengths. In this case, a table of tungsten emittance at 2000°K was used. (See Fig. 5).

Spectral sensitivity $S(\lambda)$ is determined from published spectral sensitivity curves for the film being used. In this case, the film used was Kodak 2481 High Speed Infrared film.

Transmittance $T(\lambda)$ is dependent upon the filters, which must be determined.

At each wavelength a value $P(\lambda) S(\lambda)$ is calculated and plotted as in Fig. 6.

The function was integrated by calculating the area under the curve $P(\lambda)S(\lambda)$. This integral $\int P(\lambda)S(\lambda)$ represents the response of the lamp-film system.

Fig. 5

SPECTRAL EMITTANCE CURVE, $P(\lambda)$, (TUNGSTEN, 2000°K)

10

and

SPECTRAL SENSITIVITY CURVE, $S(\lambda)$, (KODAK 2481 INFRARED)

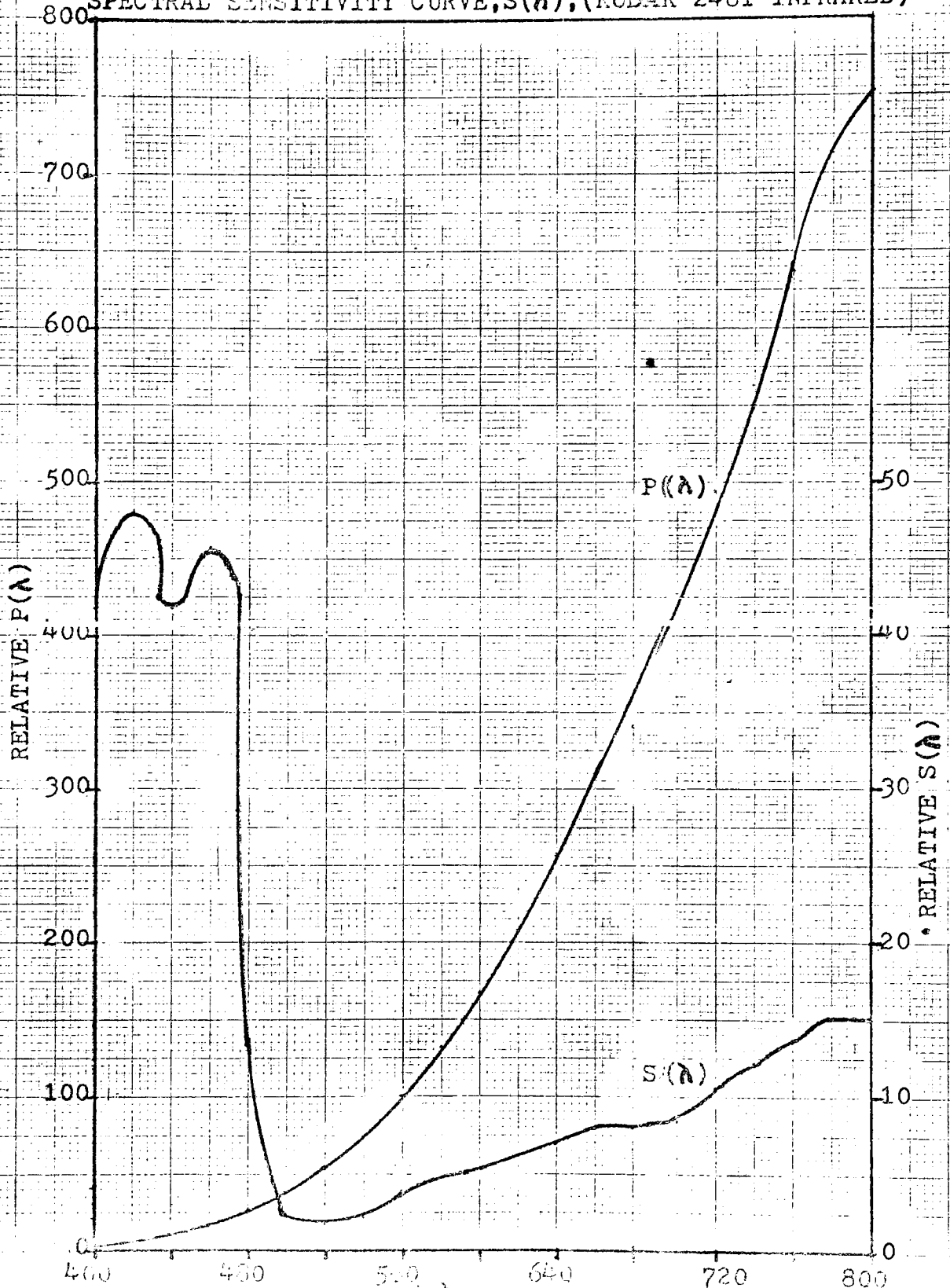
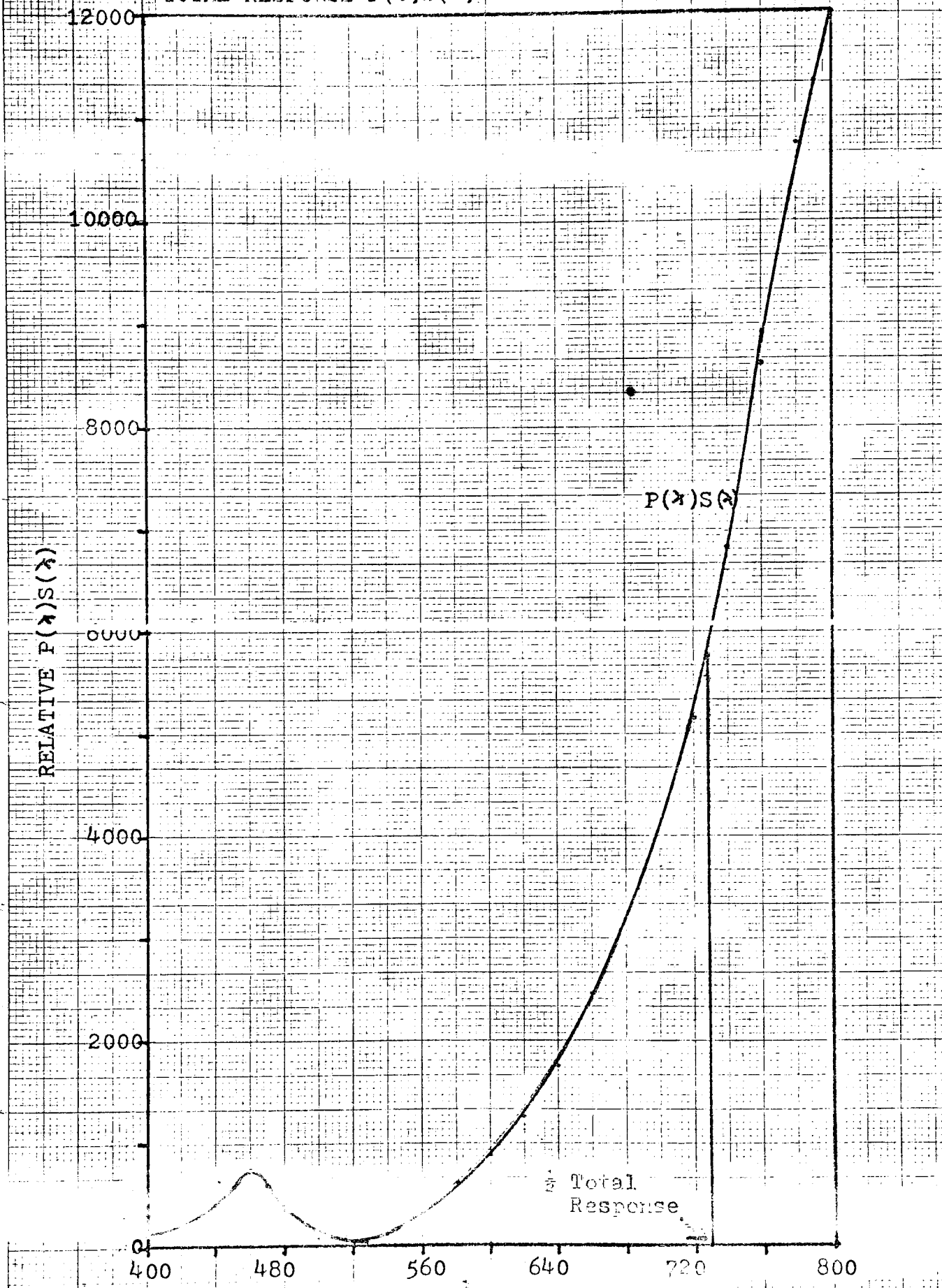

Fig. 6

TOTAL RESPONSE $P(\lambda)S(\lambda)$ OF SYSTEM



$P(\lambda)S(\lambda)$

• Total Response

The area under the curve is divided into two equal sections along the wavelength axis. The wavelength at $\frac{1}{2} \int P(\lambda) S(\lambda)$ is the point at which the two filters were chosen. At this point, both filters would transmit equal energy.

Since the cutoff point was 730nm, a Kodak 89B wratten filter and a Kodak 301 Infrared Cutoff filter were chosen. The 89B transmits above 730 nm but not below. The 301 does exactly the opposite; it transmits visible, but no infra-red.

FILM

The film chosen for this experiment was Kodak 2481 High Speed Infrared film. See spectral sensity curve in Fig. 5.

After extensive sensitometric tests, it was decided to process in the following standardized method.

Develop; D - 76, 12 minutes, 75°F.

Stop : Formula SB-5, 30 seconds.

Fix : 7 minutes.

Hypo Clear : 2 minutes.

Lamp

The tungsten ribbon filament lamp used in this experiment was a General Electric Microscope Illuminator Lamp (18A/T10/1P - 6V). That is, it used a maximum of 18 amps current and was powered by a 6-volt power supply.

The lamp was connected, in series, with a powerstat and an ammeter, as shown in figure 7.

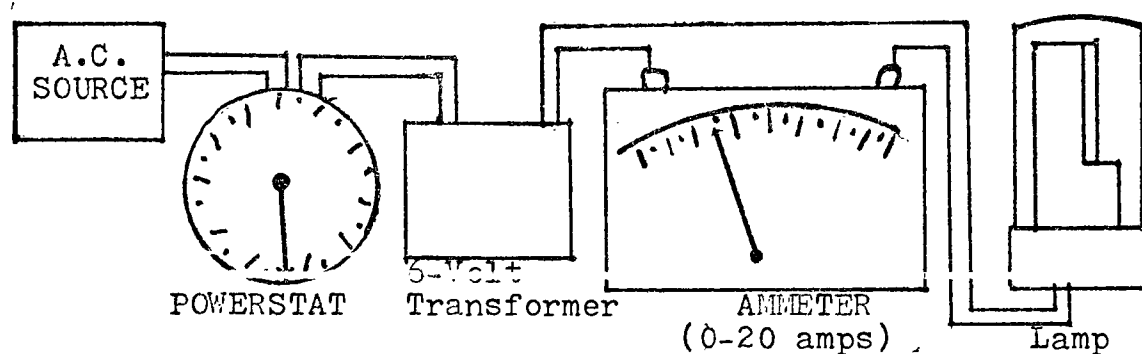

Fig. 7 Electrical Apparatus

Photometer Edge

After much faulty and inconsistent data resulted from experimenting with a mirror beam splitter which a direct double image of the lamp filament, each half of the double image through a different filter, the decision was made to revise the experimental design by building a photometric edge.

A photometric edge consisted of two highly reflectant white surfaces which joined together at a 90° angle. Using front surface mirrors, light was directed onto each

edge so that they were equally illuminated, giving off equal amounts of diffuse radiation. The filters were then placed in the path of light from the lamp to the respective mirrors, so that each edge was now illuminated with different wavelengths of radiation.

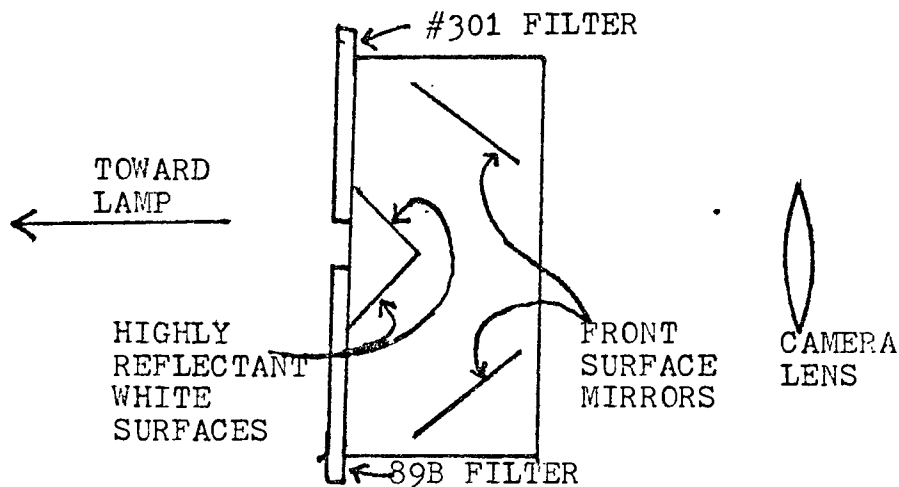

Fig. 8. Photometer Edge (Top View)

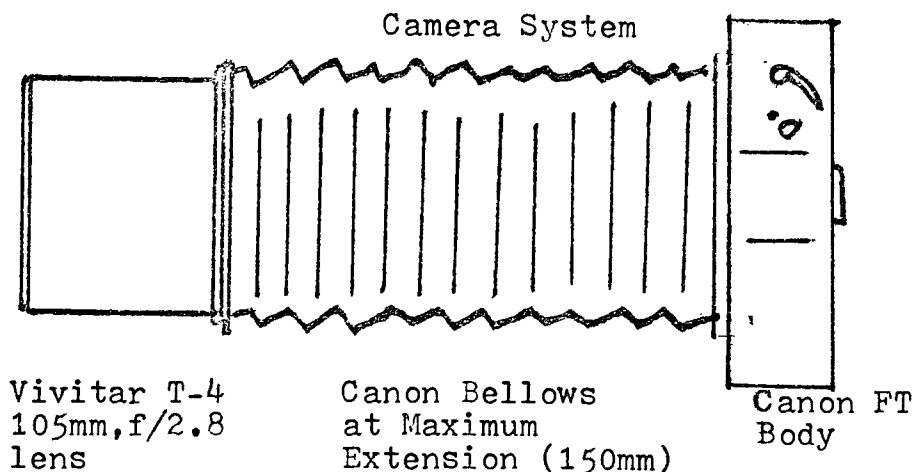
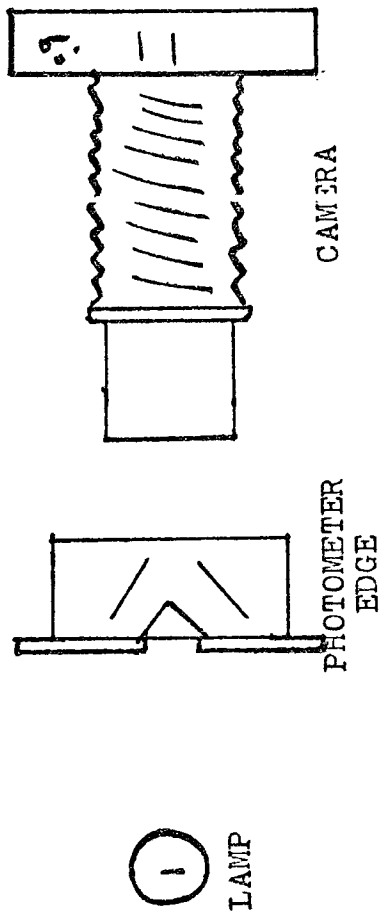

Fig. 9. Camera System

Fig. 10. COMPLETE SYSTEM (TOP VIEW)



Lamp, photometer edge, and camera are all mounted on an optical bench.

EXPERIMENTAL WORK

The lamp was photographed at an amperage range of from 12 to 18 amps, or from 2220 to 2990^oK. All readings were done on the amperage scale, for ease of working with the ammeter directly. Since we are dealing with relative values, the end results are the same if we convert from amps to color temperature for the final data. A conversion graph (amps vs color temperature) is give in figure 11.

Our mean temperature is 2600^oK , or 15 amps. At this color temperature, exposure was adjusted so as to produce equal density, thus equal relative exposure on both sides of the photometer edge. This simplifies calculations at a later time, by serving as the turning point between positive and negative $\log \bar{E}_{301} - \log \bar{E}_{89}$ values. It was found that adding 0.8 Neutral density to 89B filter, with the standard exposure of 1/30 sec. at f/2.8 satisfied the requirements.

There were a total of 5 runs in the experiment, one roll of film per run. Each run included 2 exposures each at 12, 13, 14, 15, 16, 17, and 18 amps. All exposures were 1/30 sec at f/2.8. Each roll was processed separately at the before-mentioned specifications. After processing, the image was read on the densitometer and both densities of each image were recorded. From the characteristic curve of the film, the corresponding $\log E$ values were found. The ratio R value could then be calculated using equations (9) and (10). Table 1 lists the averages for each group of 10 exposures.

Fig. 11. Color Temperature vs Amps

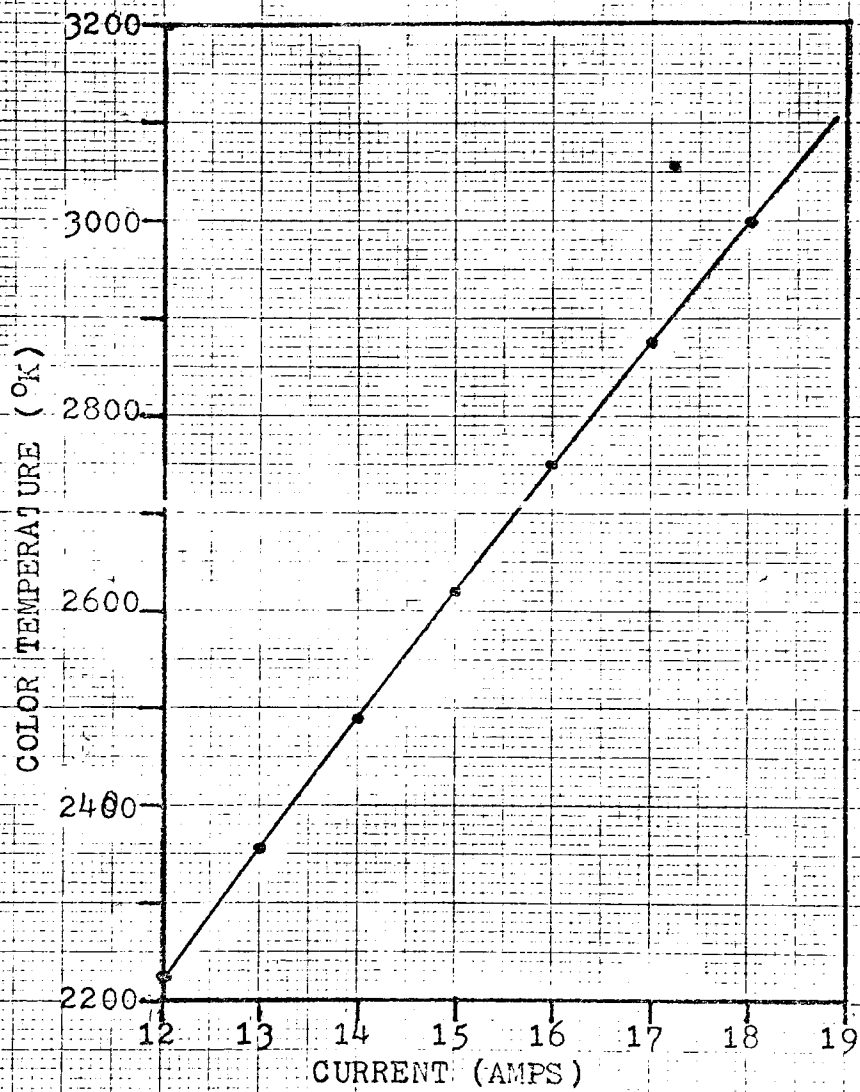

TABLE 1. CALIBRATION CURVE DATA

CURRENT	89B		301		LogE301-Log E89B	R = $\frac{E_{301}}{E_{89B}}$
	DENSITY	E	DENSITY	E		
12	.22	3.57	.16	3.41	- .16	0.69
13	.34	3.81	.26	3.66	- .15	0.72
14	.50	3.97	.44	3.91	- .06	0.87
15	.66	2.12	.66	2.12	.00	1.00
16	.82	2.28	.88	2.33	.05	1.13
17	.93	2.39	1.06	2.51	.12	1.31
18	1.04	2.49	1.22	2.66	.17	1.49

FIG. 12. CHARACTERISTIC CURVE FOR 2481 INFRARED FILM

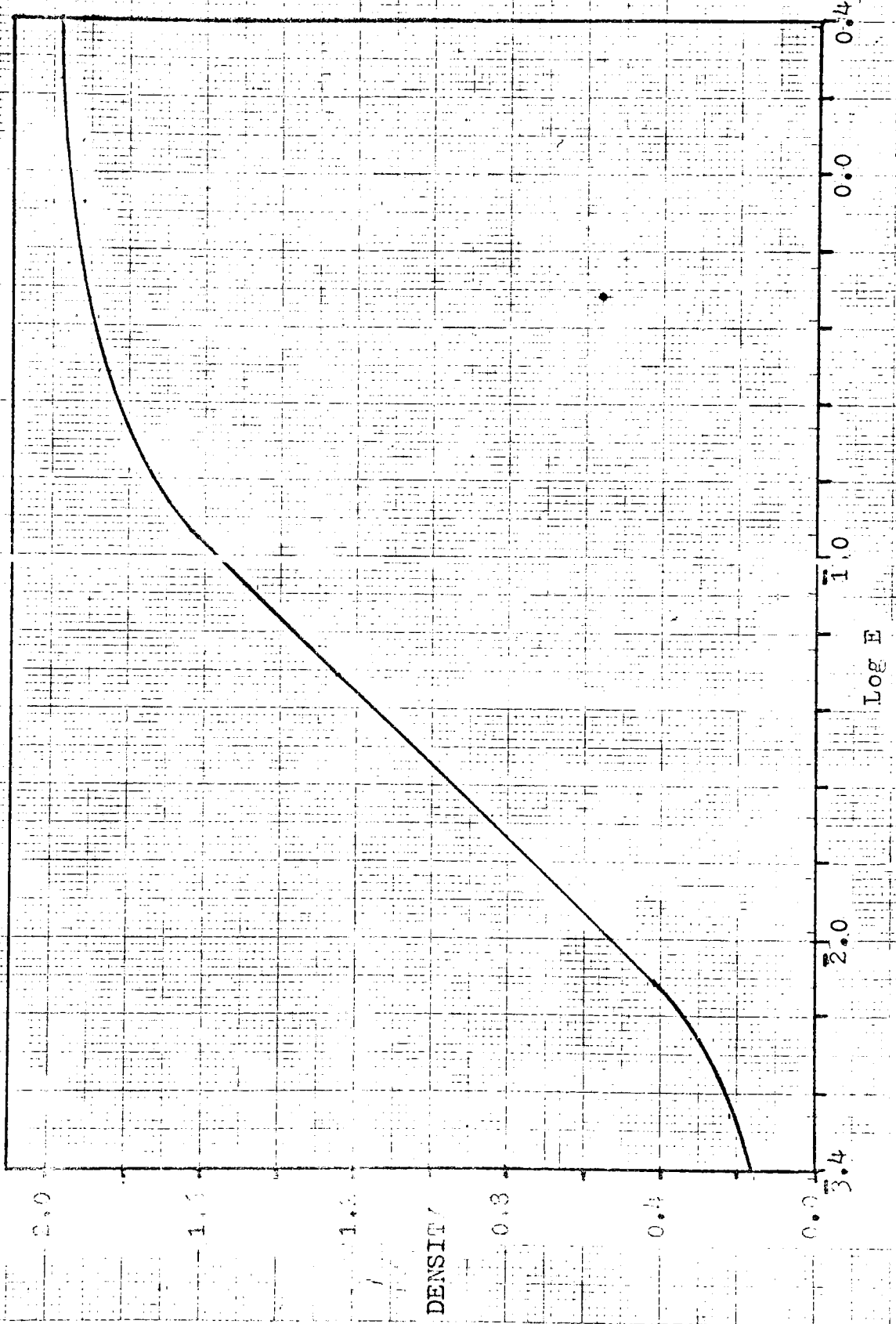

FIG. 13
DENSITY vs AMPS

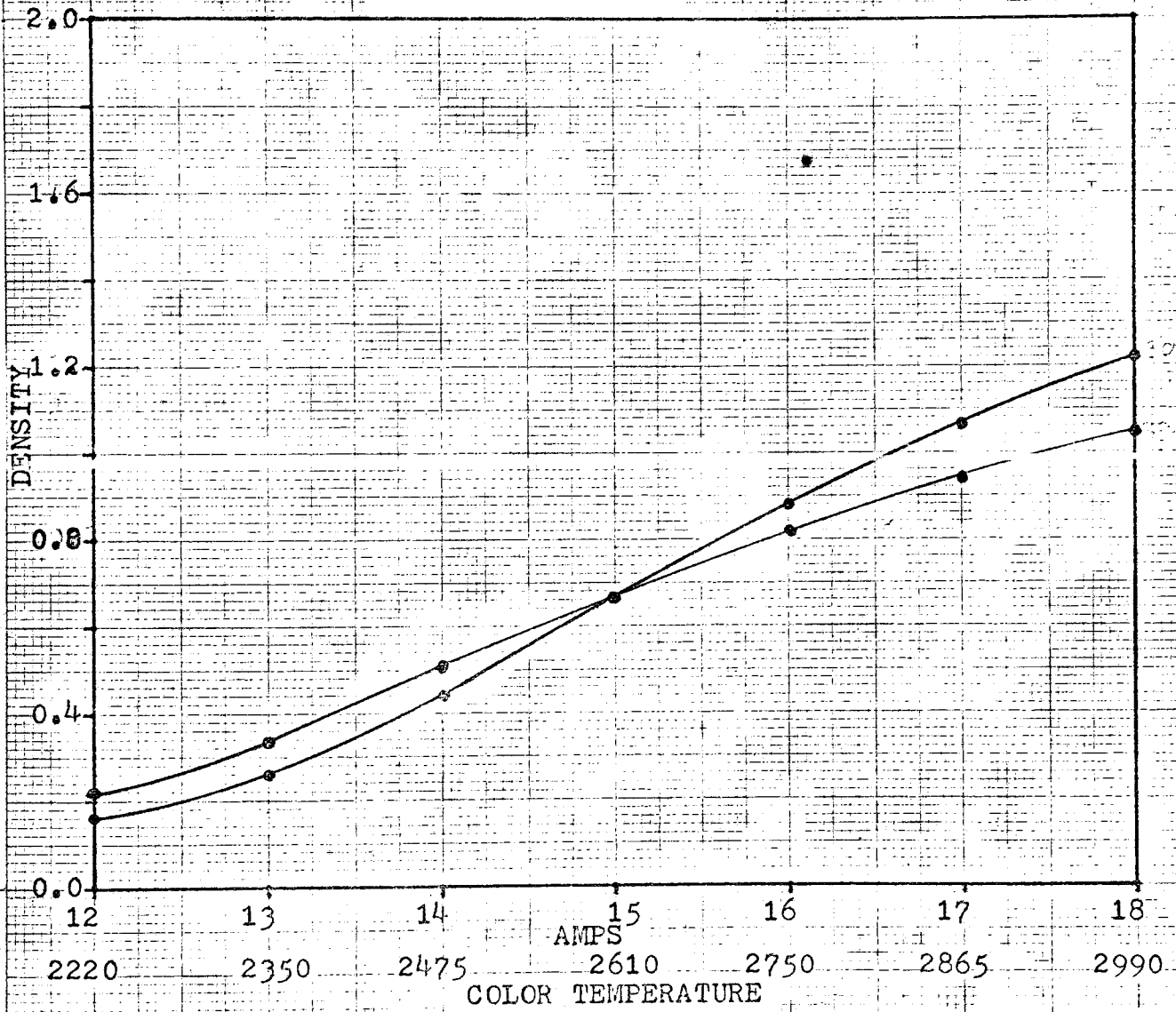

FIG. 14
Log E vs Amps

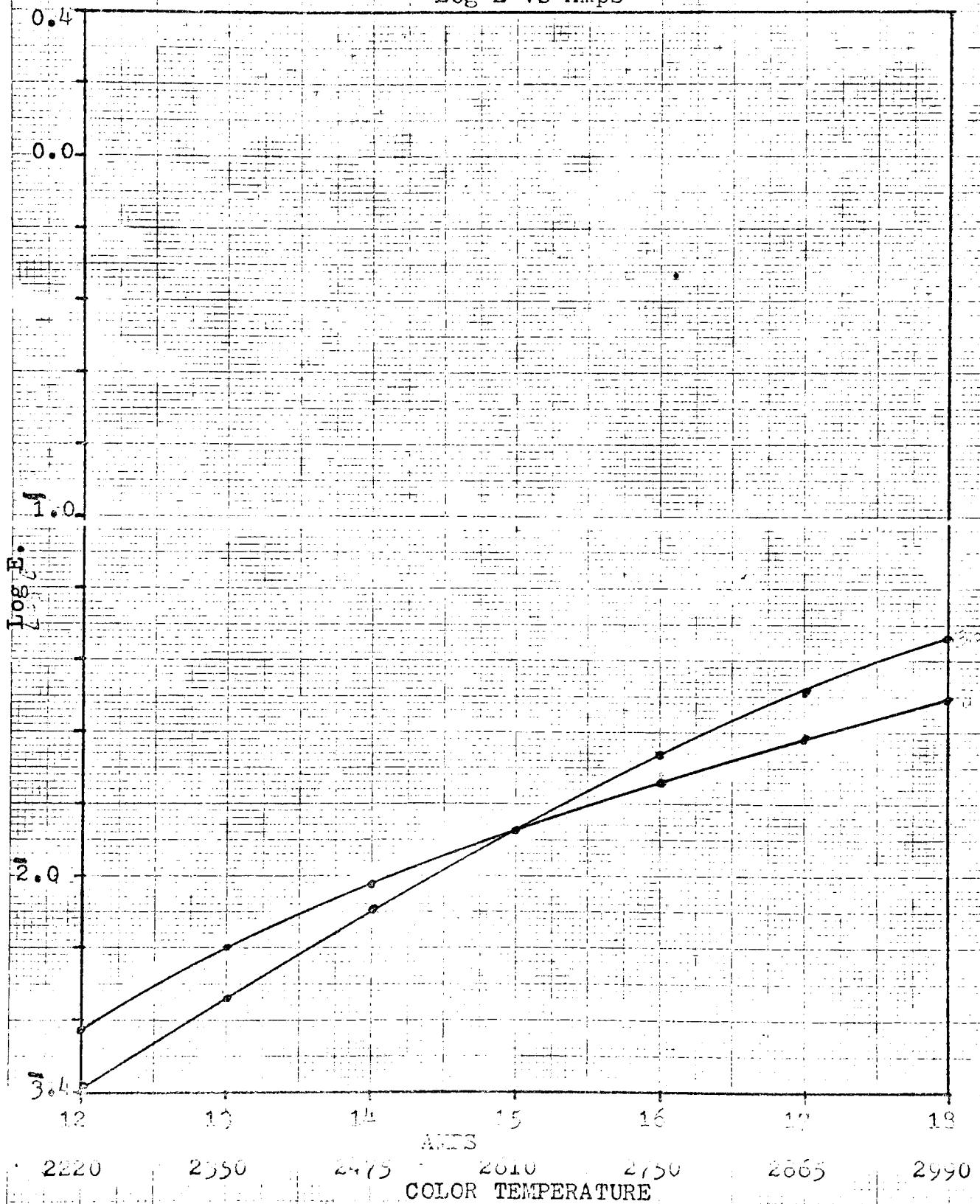

FIG. 15.
E vs AMPS

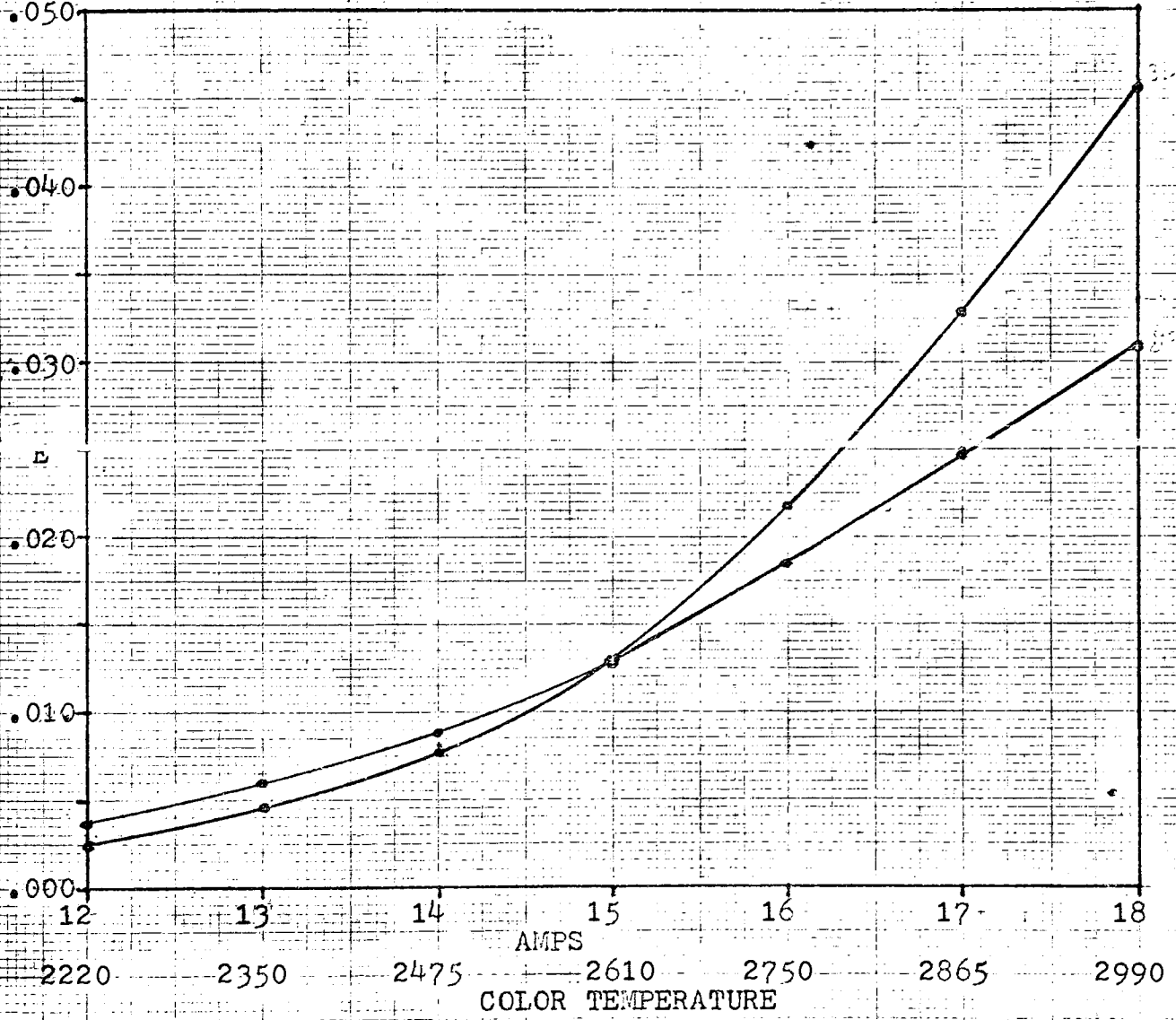
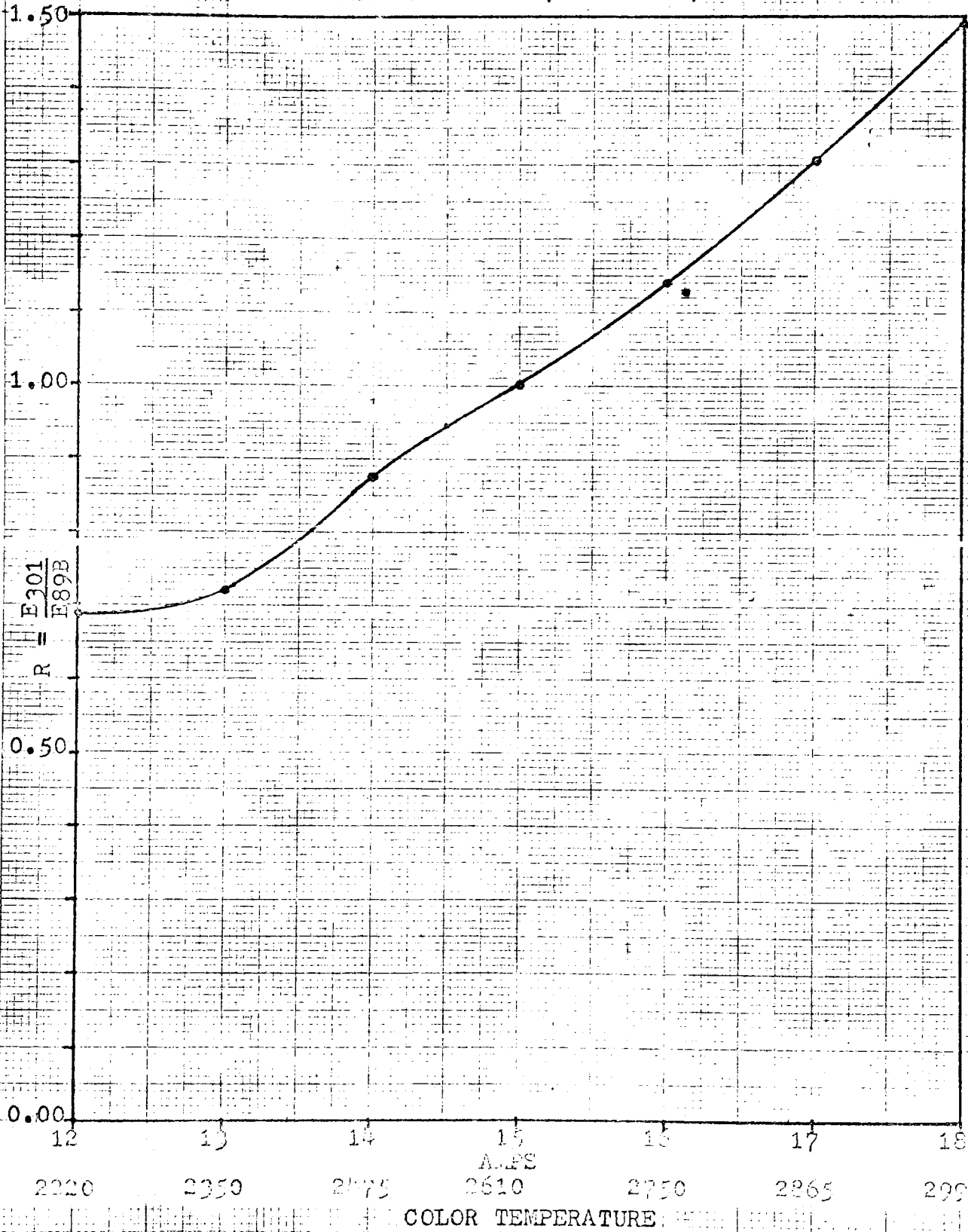

FIG. 16.
CALIBRATION CURVE (R vs AMPS)



DETERMINATION OF PERCENT OF ERROR

Three color temperatures were chosen at random from within the temperature range of the system. Upon making the appropriate settings on the ammeter, exposures were made at three runs, 2 exposures per run. After processing, densities were taken and the ratio R was calculated for each exposure. The corresponding color temperature was found on the calibration curve; the experimentally determined value was then compared with the actual preset data.

TABLE 2. PERCENTAGE OF ERROR

ACTUAL COLOR TEMP.	CALCULATED COLOR TEMP.	PERCENTAGE OF ERROR
2410 °K	2420 °K	0.42 %
2720	2730	.37
2940	2915	.85
AVERAGE		0.55 %

CONCLUSIONS

From all apparent indications, this experiment has proved successful, because the original goal, to determine a successful calibration curve to determine accurately the temperature of hot objects by photographic means.

I believe that this procedure can be utilized with any material in addition to tungsten, provided it reaches temperatures suitable enough to release infrared radiation. If this procedure were to be used on the nosecone mentioned at the beginning of this paper, the calibration source may be a piece of titanium, if that were what the nosecone were composed of.

RECOMMENDATIONS

If anyone desires to continue this work in the future, I suggest he attempt this procedure with various materials. He may also try to determine if the accuracy changes as the distance between the object and the film is changed.

BIBLIOGRAPHY

- Male, D. W. "A Photographic Pyrometer", The Review of Scientific Instruments, 22 (October, 1951), 769-772.
- Moon, Perry, The Scientific Basis of Illuminating Engineering (New York: Dover Publications, 1961), pp. 53-72, 107-139.
- Nebløtte, C.B., Photography - Its Materials and Processes (New York: D. Van Nostrand Co., Inc., 1963), pp. 13-18.
- Smith, W.J., Modern Optical Engineering (New York: McGraw-Hill Book Co., 1966), pp.193-199.
- Todd, H.N. and R.D. Zakia, Photographic Sensitometry (New York: Morgan and Morgan, Inc., 1969), pp. 23-26.
- Walsh, John W.T., Photometry (New York: Dover Publications, 1956), p. 40.